

ENTERPRISE FULLTOUCH HANDHELD COMPUTER

SF550

USER
Manual



BLUEBIRD



This user manual is protected by copyright.

Copyright © 1995-2020 Bluebird Inc. All rights reserved.

Bluebird Inc. is the designer and manufacturer of Bluebird handheld mobiles.

This manual and the programs in this device are protected under international copyright laws, and may not be copied, distributed, translated, or removed by any means.

Registered Trademark



BLUEBIRD is an emerging global brand, striving to lead the market in performance and mobility. Their products represent reliability, innovation, and innovative technology. Bluebird is a registered trademark from the global brand of Bluebird Inc. and is copyright protected.

- Bluebird and stylized Bluebird Logo are registered trademarks and symbols of Bluebird Inc.
- Qualcomm® IZat™ is a registered trademark of Qualcomm Atheros, Inc. trademark of Qualcomm Atheros, Inc.
- Adobe® is a registered trademark of Adobe Systems Inc.
- All other trademarks and copyrights are the property of their respective owners.

User's Guidance

Device type	User's guidance
Class B Device (Household Information & Communication)	This device has qualified the electromagnetic wave suitable registration and can be used as a household device at a residential area as well as any other areas.
Type Registration	This wireless device may cause propagation interference, and so, it cannot be used for life-saving services.

Revision History

Revised Version	Revised Date	Revised Details
1.0.0	Nov. 2016	First version released.
1.0.1	Nov. 2017	Updated the service center information.



This user manual is protected by copyright.

Registered Trademark

User's Guidance

Revision History

Contents

1 About This Manual

2 Safety Information

2.1 Symbols	2
2.2 Device	2
2.3 Environment	3
2.4 Battery and Charging	3
2.5 Distraction	3
2.6 Frequency Interference	3

3 Overview

3.1 Package Contents	4
3.2 Your Device	5
3.2.1 Front	5
3.2.2 Back	7
3.2.3 Bottom and Top	7

4 Getting Started

4.1 Cards	8
4.1.1 Installing the Cards	8
4.1.2 Removing the Cards	9
4.1.3 Charging the Battery	10
4.1.4 Extending the Battery Life	11

5 Basics

5.1 Turning the Device On and Off	12
5.1.1 Using Airplane Mode	12
5.2 Resetting the Device	12
5.3 Using the Touchscreen	13
5.4 Locking and Unlocking the Device	14
5.5 Using the Home Screen	15
5.5.1 Viewing the Status Bar	16
5.5.2 Notification Icons	16
5.5.3 Status Icons	16
5.6 Customizing Your Home Screen	18
5.6.1 Adding Shortcuts or Widgets	18
5.6.2 Arranging Shortcuts or Widgets	18
5.6.3 Removing Shortcuts or Widgets	18



5.7 Using Your Device with Ease	19
5.7.1 Quick Actions	19
5.7.2 Setting Date and Time	20
5.7.3 Setting the Keyboard and Language	20
5.7.4 Adjusting the Screen Brightness	20
5.8 Connectivity	21
5.8.1 Wi-Fi	21
5.8.2 Bluetooth	21

6 Applications

6.1 Installing and Uninstalling Apps	23
6.1.1 Installing App	23
6.1.2 Uninstalling App	23
6.2 Overview of Apps	24
6.3 Phone	25
6.3.1 Making Calls	25
6.3.2 Answering Calls	30
6.3.3 Viewing Call Log	31
6.3.4 Making Conference Calls	31
6.3.5 Making Emergency Calls	32
6.3.6 Making Speed dial	32
6.3.7 Phone Settings - General Settings	32
6.3.8 Phone Settings - Call Settings	33
6.4 Contacts	34
6.4.1 Creating Contacts	34
6.4.2 Editing Contacts	34
6.4.3 Finding Contacts	36
6.4.4 Calling Contacts	36
6.4.5 Messaging Contacts	36
6.5 Email	36
6.6 Snapdragon Camera	37
6.6.1 Taking Photos	37
6.6.2 Taking Photos in Panoramic Mode	37
6.6.3 Recording Videos	38
6.6.4 Camera Settings	38
6.6.5 Video Settings	40
6.7 Calendar	40
6.7.1 Creating Events	41
6.7.2 Changing Calendar View	41
6.7.3 Viewing Events	41
6.7.4 Editing and Deleting Events	41
6.7.5 Refreshing the Calendar	42
6.7.6 Searching for Events	42
6.7.7 Syncing Events	42
6.8 Clock	43
6.8.1 Alarm and clock	44
6.8.2 Timer	45
6.8.3 Stopwatch	45
6.8.4 Settings	46



6.9 Downloads.....	47
6.10 Calculator.....	47
6.11 Google Apps.....	47
6.11.1 Chrome.....	47
6.11.2 Gmail.....	47
6.11.3 Google.....	47
6.11.4 Maps.....	47
6.11.5 Play Music.....	47
6.11.6 Play Movies & TV.....	47
6.11.7 Drive.....	48
6.11.8 YouTube.....	48
6.11.9 Photos.....	48
6.11.10 Hangouts.....	48
6.11.11 Voice Search.....	48
6.11.12 Google Settings.....	48

7 Settings

7.1 WLAN.....	49
7.2 Bluetooth.....	49
7.3 Data Usage.....	49
7.4 More Settings.....	50
7.5 Buttons.....	50
7.6 Display.....	51
7.7 Sound and Notification.....	52
7.8 Storage.....	53
7.9 Battery.....	53
7.10 Apps.....	53
7.11 Users.....	53
7.12 System profiles.....	54
7.13 Location.....	54
7.14 Security.....	54
7.15 Accounts.....	55
7.16 Language and Input.....	56
7.17 Backup and Reset.....	56
7.18 Date and Time.....	57
7.19 Accessibility.....	57
7.20 Printing.....	58
7.21 About Phone.....	58

[Appendix A Device Specification](#)

[Appendix B Troubleshooting](#)

[Appendix C Safety Regulatory](#)

[Appendix D Warranty and Support](#)

1 About This Manual



The SF550 provides high quality features as a smart terminal using Bluebird's creative ideas and technological expertise. This user manual is designed to help users effectively operate the device.

- Please read this manual carefully before using the device for safe and proper use.
- This device may only be used in countries where it is sold.
- The components and colors of this device in this manual may differ from the actual product.
- Features and specifications are subject to change without prior notice.
- Content may vary by software version or by service provider.
- Apps and features may vary by country or region.
- Certain features of this device may have performance issues due to user environment, programs in use, or peripheral device usage. Bluebird is not liable for any issues caused by third-party apps or accessories.
- Modifying the device's operating system or installing software from unknown sources may cause device malfunction or data loss. Improper or unauthorized use of the device is a violation of the Bluebird license agreement and void your one-year limited warranty.

Users are able to access the 'E-Label information' in no more than three steps in a device's menu. The actual steps are : Settings > About tablet > Regulatory labels

2 Safety Information



2.1 Symbols

This manual uses the following symbols to indicate hazards and additional information.

Symbol	Name	Description
	Warning	Indicates situations that could cause injury to yourself or others.
	Caution	Indicates situations that could cause damage to your device or other equipment.
	Note	Indicates additional information that can help you get the most out of the device.

Please read this safety precaution information carefully. Failure to follow the information provided may result in fire, electric shock, or other property damage or bodily injuries.

2.2 Device

- Do not press the Power button on the device if the device is wet or do not touch adapter or power cord with wet hands. There is risk of electric shock.
- Do not use your device in an explosive danger zone.
- If your device becomes wet, do not put your device in heaters, microwaves, etc. to dry it. There is a risk of explosion or malfunction.
- Do not scratch the device's touchscreen. Use only your fingers or a compatible pen. Never use an actual pen, or any other sharp object on the touchscreen.
- Although this device is very sturdy, do not drop, hit, bend, or sit on it on purpose. It can be broken.
- Do not modify, take apart, or repair the device. Contact to your customer service center. Failure to do so will void your warranty.
- Do not attempt to modify your hardware or software. It may cause device malfunction and void your warranty.
- You may not be able to use this wireless device in basements, open fields, skyscrapers, or other places where the signal is weak.
- Backup the data and information from your device. Your data, such as ringtones, texts, and voice messages, may be erased during repairs or upgrades.
- Do not paint your device. It can damage your screen or your device's exterior.
- Avoid using or storing this device at extreme temperatures. This device is designed to work at temperatures between -20°C and 60°C (-4°F and 140°F), and humidity level between 5% and 95%.



2.3 Environment



- Do not use the device while driving or operating heavy machinery. Doing so may result in death or serious injury.
- Do not use the device in locations with combustible goods. Doing so may result in an explosion.



- Do not use the device in dusty or hot locations. Doing so may damage the device.
- Do not expose your device to direct sunlight such as on the dashboard of a car for extended periods of time.
- Do not use the device in humid locations. Doing so may damage the device and void the warranty.
- Do not keep the device close to air conditioner vents. Corrosion within the device may occur due to condensation from changes in temperature.
- Do not allow children to play with the device.

2.4 Battery and Charging



- Improper battery use may cause fire, explosion, or other hazard.
- If the battery is removed due to impact, heat, submersion, or other damage, there is a risk of explosion. Keep away from children and animals.
- Do not allow the battery's contacts to touch things like necklaces, coins, or electric conductors. Do not give any impact with sharp objects. There is a risk of explosion.



- Use only the approved battery and charger. Using an incompatible battery or charger may cause device malfunction or other damage, such as fire.
- When you are not using the device for a long period, take out the battery and keep the device and the battery in a dry, cool place. Also, charge the battery at least once a year. If you keep it without charging for a long time, it may cause device malfunction.

2.5 Distraction



In some situations, using your device may distract you and cause serious injuries and damages. For example, avoid talking on the phone or texting while driving or riding a bicycle. It is strictly prohibited by law in some jurisdictions. If you cannot avoid using your device while driving, stop your vehicle or use hand-free kit.

2.6 Frequency Interference



- This wireless device may cause radio frequency interference, so use Airplane mode or turn off the device when prohibited.
- The device emits an electromagnetic fields. It may interfere with your medical devices.
- Do not place credit cards, phone cards, bankbook, and tickets next to the device. The magnetic field of the device can damage their magnetic strips.



3.1 Package Contents

The package includes:

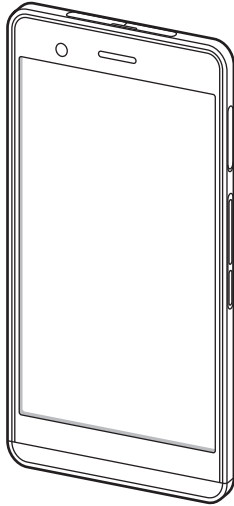

SF550 device

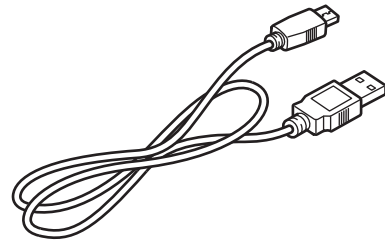

Micro USB cable

Charger

Screen Guard

SIM Remover



- The illustrations may differ from your actual items.
- To purchase additional accessories, contact your sales representative.
- You can download your User Manual from www.mypidion.com. The paper version may be available for some regions.



3.2 Your Device

3.2.1 Front

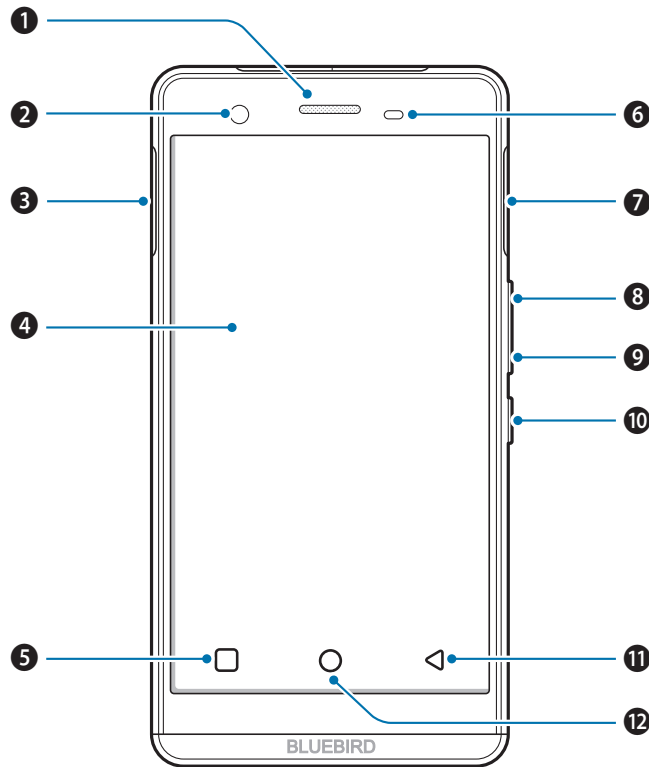

No.	Name	Description
1	Receiver	Allows user to hear the person they are talking to while on the phone.
2	Front camera	Takes selfies and records videos (5 Megapixel). You can use it when you have a video call.
3	SD card slot	Inserts a micro SD card.
4	Touchscreen	Displays apps and acts as a multi-touch interface.
5	Menu button	Displays more option menus. If you tap and hold this button for a few seconds, the apps you previously opened will be listed. Tap any app to open it.
6	Light Sensor	Sense the amount of ambient light present, and appropriately dim the device's screen to match it.
7	SIM card slot	Inserts a micro SIM card.

3 Overview



No.	Name	Description
8	Volume up button	Turns the volume up.
9	Volume down button	Turns the volume down.
10	Power button	Turns the device or screen on or off. You can lock the device by turning off the screen.
11	Back button	Returns to the previous page or menu.
12	Home button	Returns to the Home screen.



3.2.2 Back

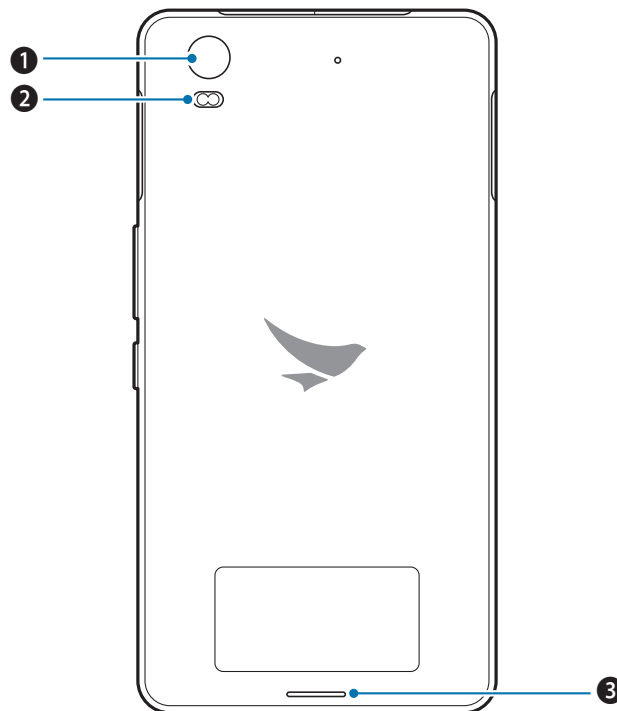

No.	Name	Description
1	Rear camera	Takes photos and record videos (13 Megapixel).
2	Flash	Illuminates your surroundings when using the camera and related apps.
3	Speaker	Emits sound.

3.2.3 Bottom and Top

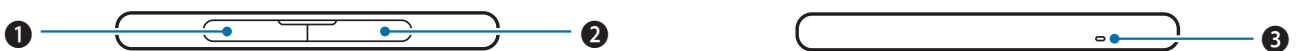

No.	Name	Description
1	Headset jack	Connects to the headset.
2	Multi-purpose jack	Connects your device with other devices, such as a computer, via a micro-USB cable.
3	Microphone	Captures sound for calling, video recording, and speech recognition.



4.1 Cards

There are slots for micro SD and micro SIM cards on the both sides of your device.

- A micro SD card is required for external storage.
- A micro SIM card is required for using mobile services.



All cards should be purchased separately if necessary. The specifications may differ according to country where the device is purchased. Contact your sales representative for more information.

4.1.1 Installing the Cards

To insert a micro SIM card

- 1 Open the cover to the SIM card slot on the right side of your device.

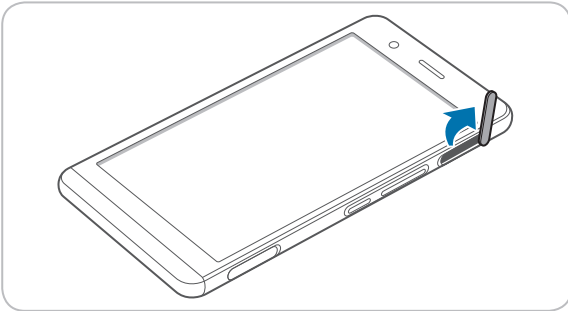

- 2 Insert a micro SIM cards into the slots. Make sure that the gold contacts on the cards are facing down.

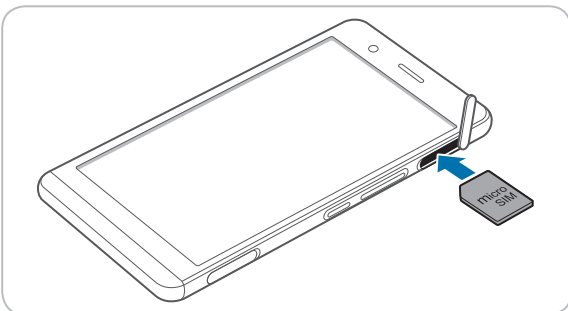

- 3 Close the cover of the SIM card slot.

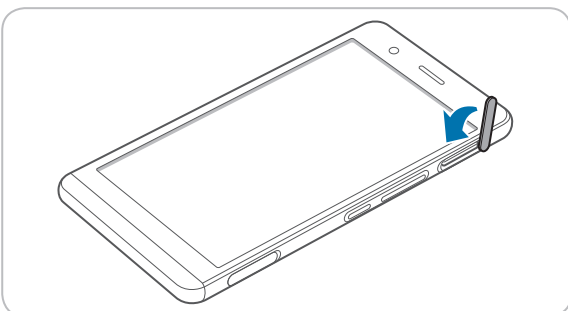

4 Getting Started



To insert the micro SD card

- 1 Open the cover to the SD card slot on the left side of your device.

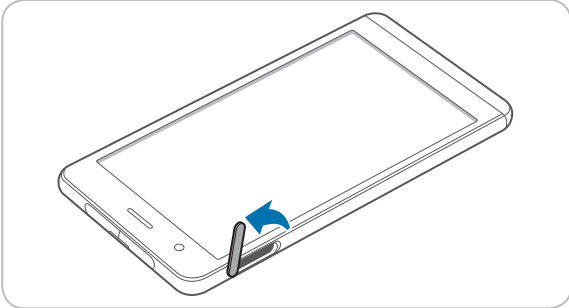

- 2 Insert a micro SD card into the slot. Make sure that the gold contacts on the card are facing down.

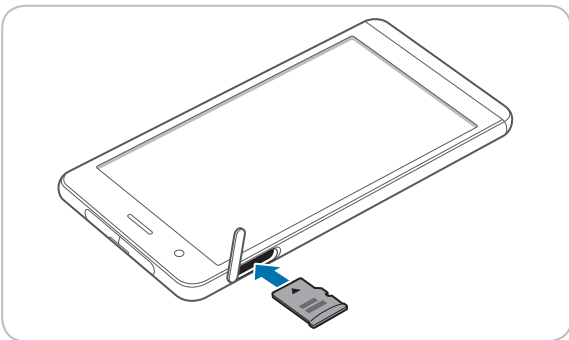

- 3 Close the cover of the SD card slot.

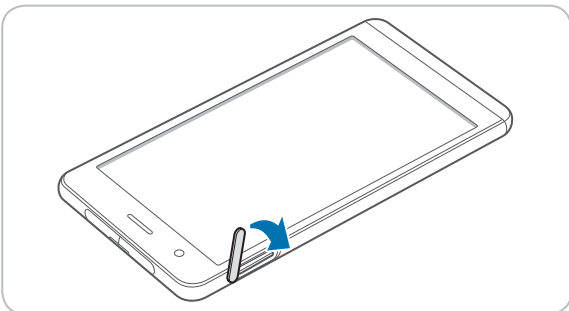

4.1.2 Removing the Cards

To remove the micro SD and SIM cards

- 1 Open the cover to each slot of your device.
- 2 Press the micro SD or SIM card into the slot to release it.
- 3 Pull the micro SD or SIM card to remove it.
- 4 Close the cover of the slot.



4.1.3 Charging the Battery

The device can be charged with a charger. You can also charge the battery by connecting it to your computer with the provided micro USB cable. Check the device's battery status on the status bar. You can also check the battery status on the lock screen.

- When the battery is low, the device will emit a sound and display a low power message.



Charge the device before using it for the first time or after not using it for a long time.

To charge with the charger

Plug the micro 5-pin end of the charger into the device's multi-purpose jack. Connect the micro USB cable of the charger with power adapter. Plug the charger into a power outlet.

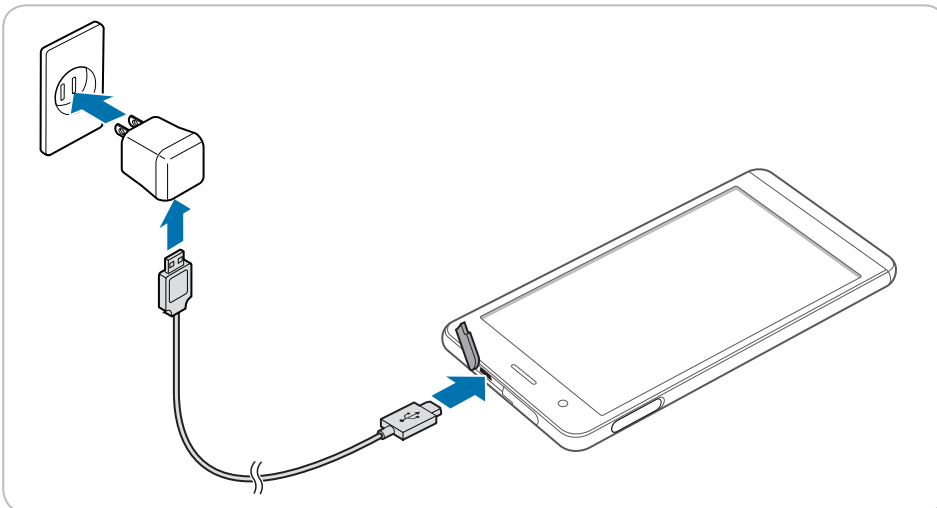

When the battery is extremely low on power, the device may not turn on. Charge the device enough and try to turn it on again. You can use the device while charging. But it may take longer to fully charge the device.











- Connect the charger properly. Failure to do so may cause damage to the device.
- The device may heat up when charging. If it gets hotter than usual, stop charging.
- Do not remove the battery before disconnecting the charger. Doing so may cause damage to the device.



4.1.4 Extending the Battery Life

You can improve the battery life in various ways. The easiest way is to use battery saver mode. When the device goes into battery saver mode, some background features and app settings may not function normally.

There are some other ways to improve your device's battery life.

- Always fully charge the battery.
- Mute unnecessary sounds, such as keypad sounds.
- Use a wired headset, rather than the loudspeaker.
- Close the Camera app whenever you have finished taking photos.
 - Tap the Back button  on Android devices.
- Decrease the length of the screen time-out.
 - On the Home screen, tap  >  **Display** > **Sleep** and set a shorter duration on Android device.
- Lower the screen brightness.
 - On the Home screen, tap  >  **Display**, and turn **Adaptive brightness** off, then tap the **Brightness level** to adjust the brightness level lower on Android device.
- Set your device to check for new mail less frequently, or even by request only.
 - On the Home screen, tap  >  **Accounts** > **Google** > and, tap an account, and then change the settings for Google on Android device.
- Disable Bluetooth when you are not using it.
- Use a Wi-Fi connection to connect to the Internet, rather than a mobile data connection.
- Prevent your device from scanning for available wireless networks.
 - On the Home screen, tap  >  **Wi-Fi** and switch the Wi-Fi to **Off** on Android device.



5.1 Turning the Device On and Off

To turn on the device, press and hold the Power button for a few seconds.

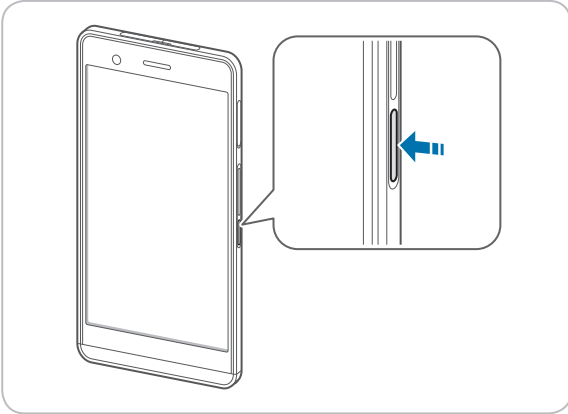

To turn off the device, press and hold the Power button, then tap **Power off**.



- To turn the screen on or off, press the Power button.
- Registering the accounts without turning on the Wi-Fi may incur extra charges depending on your data plan.



Do not turn off the device by removing the battery, as this may damage the device.

5.1.1 Using Airplane Mode

On the Home screen, tap  >  **More** and turn **Airplane mode** on. This feature disables all wireless and mobile services. Repeat the step to deactivate Airplane mode.



You can activate Wi-Fi and Airplane mode from the quick action center. Drag down from the top of the screen at any time from any menu or app and tap the **Wi-Fi** button or **Airplane mode** button.

5.2 Resetting the Device

If your device does not work properly or freezes due to unknown errors, you can force the device to restart.

To reset the device's software

On the Home screen, tap  >  **Backup & reset** > **Factory data reset**. All settings and data, including apps and personal content, will initialize, and the factory settings will be restored.







- Reset the device whose battery is charged enough not to make the device turn off suddenly during resetting. You can reset the device, charging the battery with micro USB cable when the device has low battery power.
- Back up any data and settings you want to keep before resetting the device to the factory default settings.

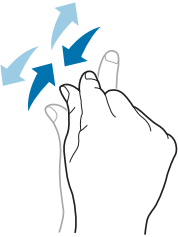

5.3 Using the Touchscreen

Use finger gestures to use the touchscreen effectively.

- ⚠ Do not touch the screen with any sharp objects.
- Do not apply too much pressure to the touchscreen.

Gesture	Name	Description
	Tap	Briefly touch an item to open, launch, or select it.
	Zoom in or out	Place two fingers on the screen and spread them apart to zoom in. Pull the fingers together to zoom out. You can also double-tap the screen quickly to zoom in or out.
	Tap and hold	Touch an item or the screen for a few seconds to access more detailed menus or options.
	Swipe	Touch the screen and quickly flick in any direction to scroll through menus or pages.
	Drag	Touch an item or the screen for a few seconds and move your finger around the screen to move the item or move through screens.



5.4 Locking and Unlocking the Device

Lock the screen to protect your device and its data.

The device locks if it is not in use for a specified period by default. To unlock the device, press the Power button to turn on the screen and drag upward from the bottom of the screen.

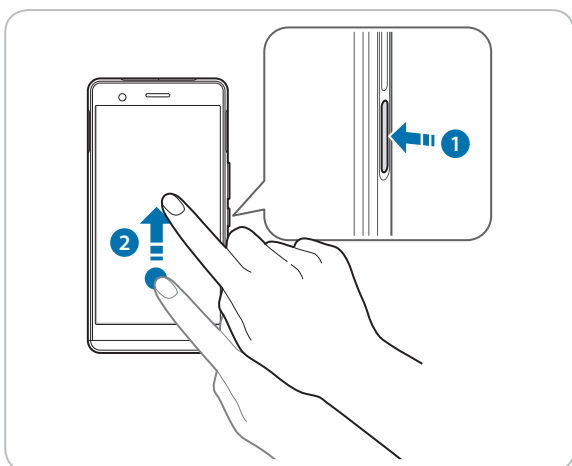

You can increase security by creating a screen pattern, a PIN, or password. For more information about how to configure and change screen lock settings, refer to *Security on page 54*.



5.5 Using the Home Screen

The Home screen is the starting point for all apps and features. It displays icons, shortcuts, and widgets for apps.

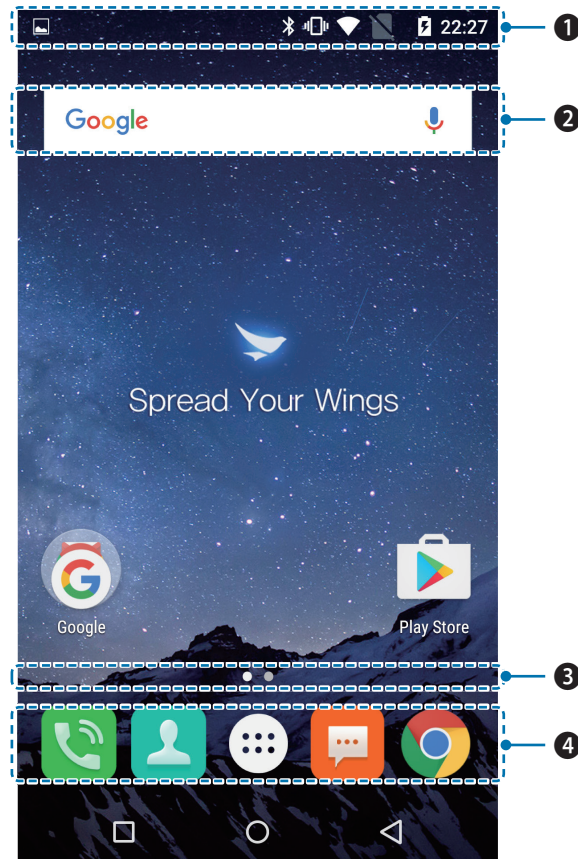

No.	Description
1	Status bar
2	Widget
3	Location indicator
4	App icons

The Home screen has multiple pages. To view other pages, swipe left or right. The white bar at the bottom of the Home screen indicates the current page you are viewing.

You can add or delete shortcuts, and widgets on the Home screen. You can also arrange the shortcuts and widgets. For more information about personalizing your Home screen, refer to *Customizing Your Home Screen* on page 18.



- To return to the Home screen, tap Home button  at any time from any menu or app.
- To view the previously opened apps, tap Menu button  and swipe between the apps. Tap any app to open it again.



5.5.1 Viewing the Status Bar

The status bar appears at the top of the screen. It displays the status icons and the current time on the right, and the notification icons on the left.



No.	Description
1	Notification icons
2	Status icons and the current time

5.5.2 Notification Icons

Notification icons in the status bar alert you to notifications, such as upcoming events, messaging, emails, missed calls, data usage, and much more.

Icon	Description
	Indicates that there are more notifications that are not displayed in the status bar.
	Indicates that data is syncing.
	Alerts you to an upcoming event.
	Indicates that a song is playing.
	Indicates that your device is uploading data.
	Indicates that your device is downloading data.
	Indicates that the micro SD card is almost full.
	Your device has detected an active USB connection.
	Indicates that your device has received a new text or multimedia message.
	Indicates that you have missed calls.

5.5.3 Status Icons

The status icons in the status bar provides information about your device's status, such as GPS, signal strength, roaming, battery charge, data, alarm, etc.

Icon	Description
	Indicates that GPS is in on.
	Indicates that your device is searching for location data.



Icon	Description
	Indicates that the alarm is set.
	Indicates that the device is set to vibrate.
	Indicates that all sounds are turned off.
	Indicates that the microphone is muted during a call.
	Indicates that the battery is fully charged.
	Indicates that the battery is partially drained.
	Indicates that the battery is low.
	Indicates that the battery is very low.
	Indicates that the battery is charging.
	Indicates that Airplane mode is active—you cannot make any calls, and other wireless functions are disabled.
	Indicates that Bluetooth is on.
	Indicates that your device is connected to a Wi-Fi network.
	Indicates that there is no Wi-Fi signal.
	Indicates that you are in range of your mobile network and it indicates the mobile network's signal strength.
	Indicates that there is no mobile network signal.
	Indicates that your device is connected to a 4G network.
	Indicates that your device is connected to a 3G network.
	Indicates that your device is connected to an HSPA network.
	Indicates that your device is connected to an EDGE network.
	Indicates that your device is connected to an GPRS network.
	Indicates that there is no SIM card installed.



- Other than the icons described in the table above, there are various other notifications and status icons that are displayed on the status bar depending on the situation.
- When the icons on the status bar are hidden, tap the status bar on the screen to display icons temporarily.
- The appearance of icons may vary depending on your region or network service provider.



5.6 Customizing Your Home Screen

You can customize the Home screen by adding shortcuts and widgets.

5.6.1 Adding Shortcuts or Widgets

Shortcuts added on the Home screen allows you to access and launch apps or activate a feature quickly and easily. Widgets appear as on-screen apps.

On the Home screen, tap  to view your all apps under the **APPS** tab or all widgets under the **WIDGETS** tab. Locate an app or widget, and tap and hold the item until the Home screen appears. Position the item on the screen and release.



The same shortcuts or widgets can be added to any of the available screens.

5.6.2 Arranging Shortcuts or Widgets

Tap and hold the shortcut icon or widget you want to move. Drag the shortcut icon or widget to a new location. To place the item on a different page, drag it to the edge of the screen.



To change the size of your widget, tap and hold the widget on the Home screen. Release the item and a white box will be displayed around the widget. Drag the white dots to change the size. It is not available for some widgets.



5.6.3 Removing Shortcuts or Widgets

Tap and hold an shortcut icon or widget. Drag it to **X Remove** at the top of the screen. When the item turns red, release it.



5.7 Using Your Device with Ease

Make it easier to see, hear, and use the device with its built-in accessibility features.

On the Home screen, tap  >  **Accessibility** and make the text size bigger, increase text contrast, and more to fit your individual needs. For more information on configuring Accessibility settings, refer to *Accessibility on page 57*.

5.7.1 Quick Actions

Access the most frequently used settings quickly with quick action, turning them on or off in an instance.

- 1 Drag down from the top of the screen at any time from any app and tap a quick action button to turn it on or off.

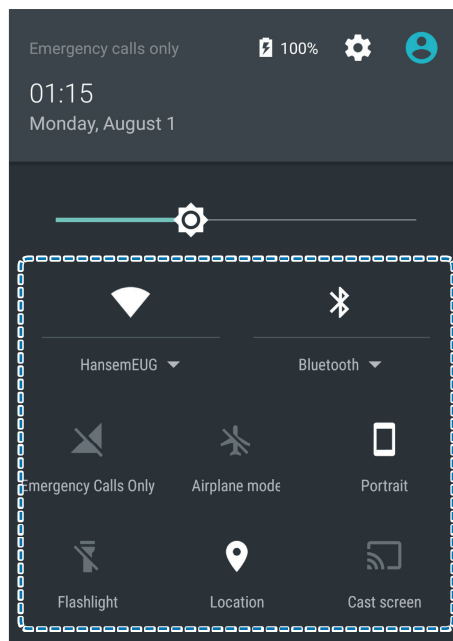



- 2 Drag up from the bottom of the screen or tap the Back button .



5.7.2 Setting Date and Time

The date and time are automatically set based on the network you are connected to.

To set the date and time manually

On the Home screen, tap  >  **Date & time**, then disable **Automatic date & time**. If you turn off this option, the options for setting date and time will be activated.



To set the date and time automatically

On the Home screen, tap  >  **Date & time**, then enable **Automatic date & time**.

To set the date and time format

On the Home screen, tap  >  **Date & time**, then turn **Use 24-hour format** on or off.

5.7.3 Setting the Keyboard and Language

On the Home screen, tap  >  **Language & input** to change the language and the keyboard you use. For more information, refer to *Language and Input* on page 56.

5.7.4 Adjusting the Screen Brightness



- 1 On the Home screen, tap  >  **Display** > **Brightness level**.
- 2 Tap and move the slider to adjust the screen brightness.



5.8 Connectivity

5.8.1 Wi-Fi

Connecting to a Wi-Fi network is an easy way of accessing the Internet. When you are out, you can connect to Wi-Fi networks in public places, such as libraries or coffee shops.

- 1 On the Home screen, tap  >  **Wi-Fi**.
- 2 Make sure switch the Wi-Fi to **On**.
- 3 Tap the network you want to join.
- 4 If necessary, enter the password for the network and tap **CONNECT**.

To close the connection, switch the Wi-Fi to **Off**.



Your device periodically checks for and notifies you of available connections. The notification appears briefly at the top of the screen.

5.8.2 Bluetooth

You can connect wirelessly to various Bluetooth-compatible devices, such as phones and computers. You can also send your photos to Bluetooth-compatible phones or to your computer.

On the Home screen, tap  >  **Bluetooth**.

Because devices with Bluetooth wireless technology communicate using radio waves, they do not need to have a direct line of sight. However, they must be within 10 meters (33 feet) of each other, although the connection may be subject to interference from obstructions, such as walls or from other electronic devices.



- Paired devices can be connected to your device when Bluetooth turns on.
- Other devices can detect your device only if the Bluetooth settings view is open.



Do not accept the requests from unknown devices and also do not try to pair with an unknown devices. This helps to protect your device from harmful content.



To pair with a Bluetooth device

Pair your device with Bluetooth compatible devices.

1 On the Home screen, tap  >  **Bluetooth**.

2 Turn the Bluetooth **On**.



Make sure the devices you want to pair with have Bluetooth enabled.

3 On the Bluetooth device list, tap the device you want to pair with.

4 Type or confirm the PIN, and tap **PAIR**, if required.



- The passcode, which you can create, must be entered on both devices. The PIN in some devices is fixed. For details, see the user guide of the other device.
- A PIN is only used when you connect to something for the first time.

When your device has paired with other devices via Bluetooth, your devices will automatically pair in the future when in range.

To unpair a Bluetooth device

Unpair your device with other device you paired.

1 On the Home screen, tap  >  **Bluetooth**.

2 Tap device's name to disconnect it.

3 Tap **FORGET**.

To send content via Bluetooth

Use Bluetooth to wirelessly share your photos or other content with Bluetooth-compatible devices or to your computer. You can use more than one Bluetooth connection at a time.



6.1 Installing and Uninstalling Apps

You can purchase and download apps.

On the Apps screen, tap  or  located in the top right of the screen.

6.1.1 Installing App

In the Play Store, browse apps by category or enter the keywords on search field to search for a keyword.

Select an app you want to install and see whether the app is free or not.

- To download a free app, tap **INSTALL**.
- To purchase and download a paid app, tap the price and follow the on-screen instructions.



To change the auto update settings, tap  > **Settings** and switch the **Auto-update apps**, and then select an option.













6.1.2 Uninstalling App

On the Apps screen, tap and hold the Menu button  > **Manage apps**. Tap the app that you want to remove and tap **UNINSTALL**.



6.2 Overview of Apps

On the Home screen, tap  to view your all apps. All the apps on your device will be displayed under the **APPS** tab. The **WIDGETS** tab shows all widgets that can be placed on the Home screen.

Icon	Name	Description
	BBUpdate	Use to update your device.
	Calculator	Use for mathematical calculations. For more information, refer to <i>Calculator on page 47</i> .
	Calendar	Use to create, view, and manage events. For more information, refer to <i>Calendar on page 40</i> .
	Snapdragon Camera	Use to take photos or record videos. For more information, refer to <i>Snapdragon Camera on page 37</i> .
	Clock	Use to set an alarm, view current times around the world, and use a timer or a stopwatch. For more information, refer to <i>Clock on page 43</i> .
	Contacts	Use to add, view, and edit your contacts. For more information, refer to <i>Contacts on page 34</i> .
	Production Testing Tool	Use to view device version information, check your device, or to reset your device.
	Downloads	Use to view all downloaded files. For more information, refer to <i>Downloads on page 47</i> .
	Email	Use to send or view emails. For more information, refer to <i>Email on page 36</i> .
	Phone	Use to make phone calls. For more information, refer to <i>Phone on page 25</i> .
	Settings	Use to configure your device. For more information, refer to <i>Settings on page 49</i> .
	SIM Toolkit	Use various apps provided by the inserted SIM card.



6.3 Phone

6.3.1 Making Calls

On the Home screen, tap > . You can also directly open the Phone app from the lock screen. Swipe the screen to left while tapping .

You can simply dial the number, tap on a number on the call log, or choose a number in your contacts.



Because the SF550 has two SIM cards, you can choose to use a SIM card based on your location or preference.

To make a call on the dialer screen

- 1 On the Home screen, tap > .
- 2 Tap on your Phone app.

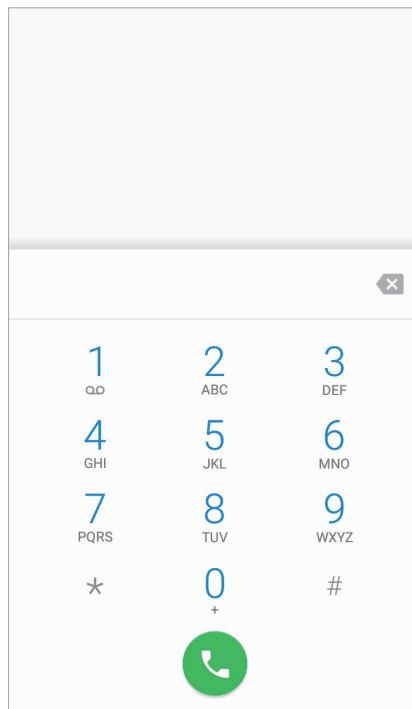

- 3 Tap the keypad, enter a phone number, then tap to call.



Touch and hold number 1 key to use voicemail.





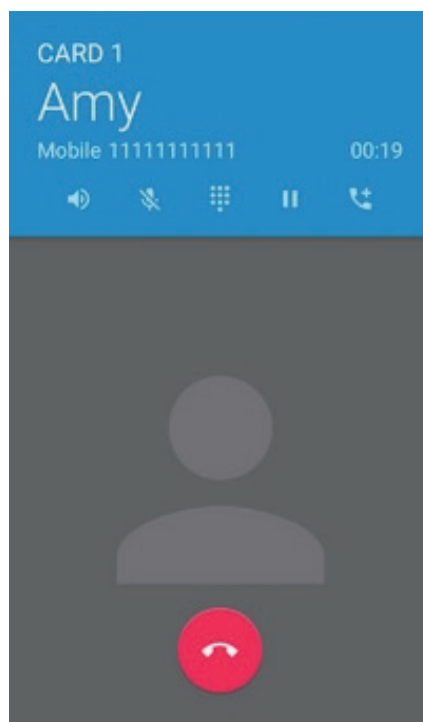

Enter digits and tap on this screen for dialing options.

- **Add to contacts:** Select to add a number to the contacts list as a new contact or as an existing contact.
- **Add 2-sec pause:** Select to add a two-second pause before the phone dials the following sequence of digits. Multiple pauses can be added.
- **Add wait:** Select to make the phone dial the sequence of digits when you tap **Yes** on the pop-up screen.
- **Send text message:** Select to send a text message to the dialed number.



To use options during your call





Icon	Description
	Turn the speakerphone on.
	Mute your microphone.
	Open the keypad.
	Hold a call.
	Add another person to the call.
	End the call.

6 Applications



To make a call from contacts list

- 1 On the Home screen, tap  > .
- 2 Tap the **CONTACTS** tab on your Phone app.

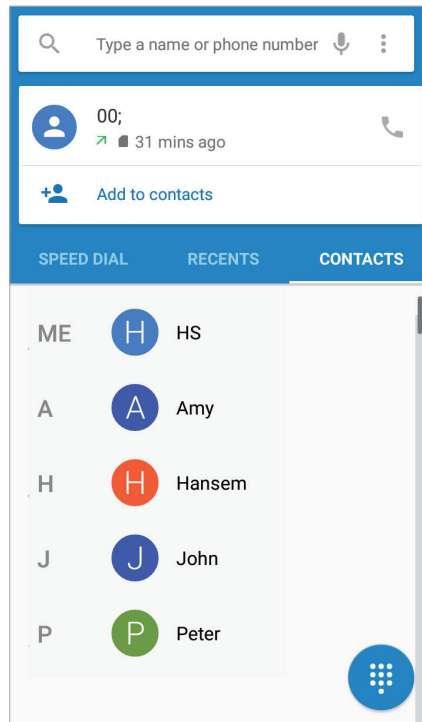



- 3 Tap a name in your contacts list and then tap a phone number to dial the number.

6 Applications



To make a call from call log

- 1 On the Home screen, tap  > .
- 2 Tap the **RECENTS** tab on your Phone app. You can also open the call log by tapping  > **Call History**.

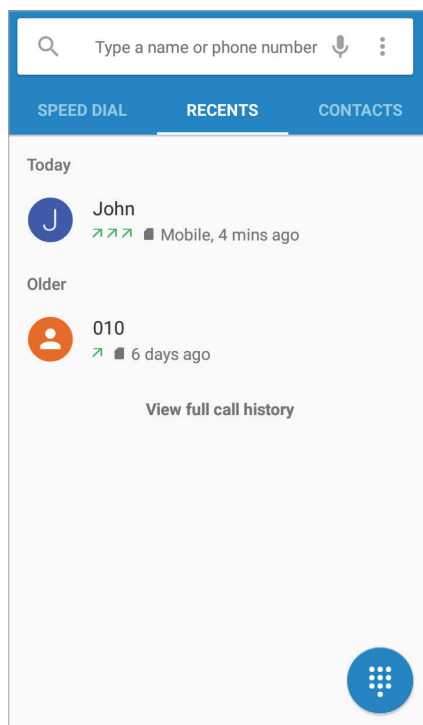



- 3 Tap a name > **CALL BACK** to dial the number.



To make a call from speed dial

You can make quick calls without entering a phone number or searching for a contact with the speed dial function. You should assign a speed dial number to a contact first. For more information on creating new speed dial, refer to *Making Speed dial on page 32*.

- 1 On the Home screen, tap  > .
- 2 Tap the **SPEED DIAL** tab on your Phone app.

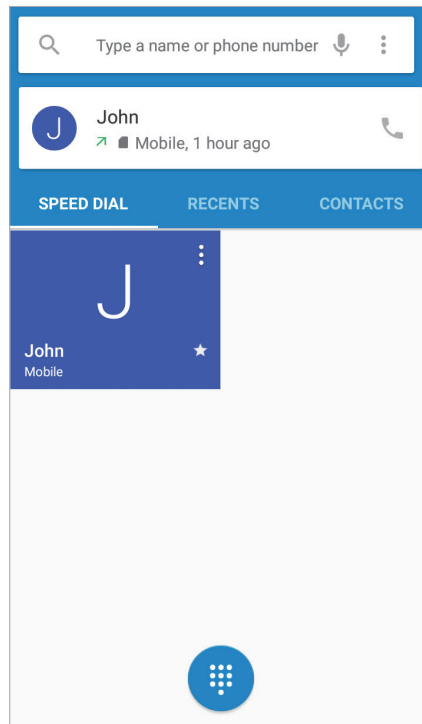

- 3 Tap any speed dial contact to dial the number.





6.3.2 Answering Calls

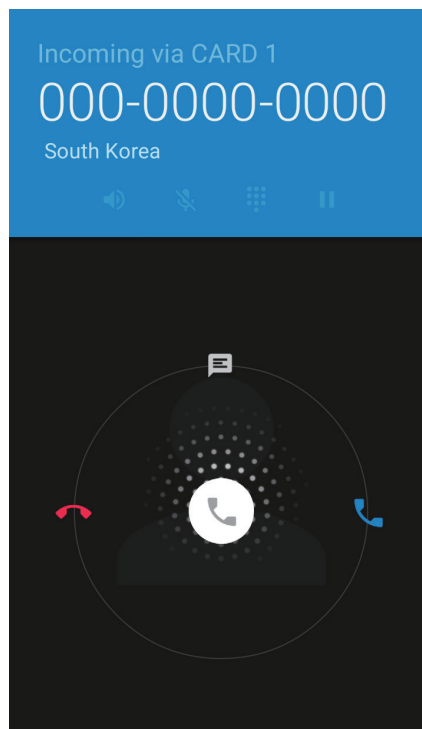

When you receive a phone call, the incoming call screen opens with the caller ID, and any other available information, such as the caller's name, if saved in the contacts list.

Tap and drag  to one of the following icons:



Icon	Description
	Answer an incoming call.
	Decline an incoming call and divert it to voicemail.
	Decline an incoming call and send a text message.





- To silence the ringtone of an incoming call or to stop the vibration, press the Volume down button on the side of the device.
- To edit the quick text responses for declining a call, tap  >  >  > **Settings** > **General settings** > **Quick responses**.



6.3.3 Viewing Call Log







The call log displays the dialed, missed, and received calls.

- 1 On the Home screen, tap  > .
- 2 Tap the **RECENTS** tab on your Phone app. You can also open the call log menu by tapping  > **Call History**.



Icon	Description
	Missed incoming calls
	Received incoming calls
	Outgoing calls

6.3.4 Making Conference Calls

You can make a conference call with many people. The maximum number of people who can be in a conference call at once depends on your service provider.

- 1 On the Home screen, tap  >  > .
- 2 Make a call first and tap  to add another person to the call.
The first call will be put on hold.
- 3 Dial the second number and make the call.
- 4 When the second call is connected, tap  to create a conference call with three people.
- 5 To add another person to the conference call, tap .
- The conference call will be put on hold.
- 6 Dial the third number and make the call.
- 7 When the call is connected, tap to  add the line to the conference call.

You can do following options during the conference call.

- To view all callers participated in the conference call, tap **Manage conference call**.
- To disconnect one caller from the conference call, tap **Manage conference call** > .
- To separate one caller from the conference all, tap **Manage conference call** > .





6.3.5 Making Emergency Calls

You can make emergency calls to 911 even when your phone is locked, not registered for mobile network service, or a SIM is not inserted. No charges for making emergency calls.





 The emergency numbers may vary by country.

6.3.6 Making Speed dial

To create a new speed dial

- 1 On the Home screen, tap  > .
- 2 Tap the **CONTACTS** tab on your Phone app.
- 3 Tap a name in your contacts.
- 4 Tap  to add the number you selected as a speed dial.

To edit speed dial

- 1 On the Home screen, tap  > .
- 2 Tap the **SPEED DIAL** tab on your Phone app.
- 3 Select the name you want to edit and tap  > .

6.3.7 Phone Settings - General Settings

On the Home screen, tap  >  >  > **Settings** > **General settings** on any tab on your Phone app. This General settings menu can only be accessed through this app. You can modify various call options.

Contact display options

- **Sort by:** Tap to select the sorting method of contacts. You can select **First name** or **Last name**.
- **Name format:** Tap to select the format the names are displayed in. You can select **First name first** or **Last name first**.

Sounds and vibrate



- **Phone ringtone:** Tap to select the ringtone to alert you of incoming calls. Tap a ringtone to play it. If you decide to set it as a ringtone, tap **OK**. If not, select another ringtone or tap **CANCEL**.
- **Dialpad tones:** Tap and select the checkbox to play a sound when tapping the keypad.
- **Also vibrate for calls:** Tap and select the checkbox to set your device to vibrate and emit ringtone at the same time for incoming calls.

Other

- **Quick responses:** Tap and edit the quick responses to use when declining a call.



6.3.8 Phone Settings - Call Settings

On the Home screen, tap  >  >  > **Settings** > **Call settings** on any tab on your Phone app. This Call settings menu can only be accessed through this app. You can modify various call options.

SUBS Settings

- **Voicemail:** Tap to set up your voicemail.
 - **Service:** Tap to set the provider of the voicemail service.
 - **Setup:** Tap to set the voicemail number.
 - **Sound:** Tap to select the ringtone to alert you of a new voicemail message.
 - **Vibrate:** Tap and select the checkbox to set your device to vibrate for a new voicemail message.
- **Fixed Dialing Numbers:** Use a Fixed Dialing Number (FDN) to limit your phone to dial only the phone numbers or area codes saved in the FDN list.
 - **Enable FDN:** Tap and select the checkbox to enable FDN.
 - **Change PIN2:** Tap to change the PIN for FDN access.
 - **FDN list:** Tap to manage the FDN list.
- **GSM call settings:** Tap to set the additional Global System for Mobile communications (GSM) only call settings.
 - **Call forwarding:** Tap and set to forward incoming calls to a different phone number.
 - **Additional settings:** Tap to select to activate the caller ID and call waiting feature.
- **CDMA call settings:** Tap to set the additional Code Division Multiple Access for mobile communication.
 - **Voice privacy:** Tap and select the checkbox to enable enhanced privacy mode.



Because SF550 has two SIM cards, you can specify the SUBS settings separately.

Other call settings

- **Phone account settings**
 - **Make calls with:** Tap to set the used cards for calling.
 - **SIP accounts:** Tap to choose to receive Internet calls for an account added to the device, to view or change SIP accounts, or to add accounts.
 - **Use SIP calling:** Tap to select the situations when you will use SIP calling.
 - **Receive incoming calls:** Tap and select the checkbox to receive incoming SIP calls. If you enable this option, the device will consume more battery power.
- **TTY mode:** Tap and select the TTY mode.
 - **TTY Off:** TTY mode is off.
 - **TTY Full:** Turn TTY on.
 - **TTY HCO:** Enable HCO (Hearing Carry over). HCO feature is designed for the people who can hear, but have difficulty speaking on the phone. You type the outgoing text but listen to the incoming text.



- **TTY VCO:** Enable VCO (Voice Carry over). VCO feature is designed for the people who can speak, but have difficulty hearing on the phone. You can use your voice to speak and read the other person's response in a text typed by the operator.
 - ✔ • Use a TSB-121 cable to connect the TTY device to your phone. If this cable is not provided with your TTY device, contact your TTY device manufacturer.
 - Use the ear pieces and headsets with caution when increasing the volume while using the HCO feature.
 - Teletypewriter or text telephone (TTY) mode is a telecommunications service that allows people with hearing problems, or speech or language disabilities, to send and receive text information over a telephone connection.
- **DTMF tones:** Tap to set the length of dual tone multi frequency (DTMF) tones. You can choose it to be normal (default) or long tones.
- **X-Divert:** Tap to specify the CFNRC (Call Forwarding When Not Reachable) settings. Enter the Sub1 and Sub2 numbers and enable or disable the X-Divert setting.





6.4 Contacts

Use the Contacts app to add, view, and edit your contacts. The app has two tabs to view your contacts: **FAVORITES**, **ALL CONTACTS**.

On the Home screen, tap  > , or you can add widgets for your most frequently used contacts to the Home screen.





6.4.1 Creating Contacts

You can add contacts and synchronize them with your accounts that support syncing contacts.

- 1 On the Home screen, tap  > .
All your contacts are listed in the **ALL CONTACTS** tab.
- 2 Tap  at the bottom right of the screen.
- 3 Add information and photo to the contact.
- 4 When you are finished, tap  on the top left of the screen.

6.4.2 Editing Contacts



To edit contact details

- 1 On the Home screen, tap  > .
All your contacts are listed in the **ALL CONTACTS** tab.
- 2 Tap the name of a contact to view their details. Tap .
- 3 When you are finished, tap  on the top left of the screen.







To set a contact's default phone number



When there are two or more phone numbers saved for a contact, you can set a default phone number.

- 1 On the Home screen, tap  > .
All your contacts are listed in the **ALL CONTACTS** tab.
- 2 Tap a name in your contacts to view their details.
- 3 Tap and hold the phone number you want to set as the contact's default number.
- 4 Tap **Set default** from the pop-up menu.
The default number appears on top.





To set a ringtone for a contact

- 1 On the Home screen, tap  > .
All your contacts are listed in the **ALL CONTACTS** tab.
- 2 Tap the name of a contact to view the details.
- 3 Tap  >  > **Set ringtone**.

To place a contact on the Home screen

- 1 On the Home screen, tap  > .
All your contacts are listed in the **ALL CONTACTS** tab.
- 2 Tap the name of a contact to view their details.
- 3 Tap  > **Place on Home screen**.
A widget for the contact will be created on the Home screen.

To delete a contact



- 1 On the Home screen, tap  > .
All your contacts are listed in the **ALL CONTACTS** tab.
- 2 Tap the name of a contact to view their details.
- 3 Tap  >  > **Delete**.

6 Applications





6.4.3 Finding Contacts



You can search for contacts by name or number.

- 1 On the Home screen, tap  > .
All your contacts are listed in the **ALL CONTACTS** tab.
- 2 Enter letters of their name or digits of their phone number.
As you type, contacts that includes the letters or numbers will appear below the search box.
- 3 Tap the contact you are searching for to view it.

6.4.4 Calling Contacts

- 1 On the Home screen, tap  > .
All your contacts are listed in the **ALL CONTACTS** tab.
- 2 Tap the name of a contact to view their details.
- 3 Tap the phone number.
It calls the number at once. For more information, refer to *Making Calls on page 25*.



6.4.5 Messaging Contacts

- 1 On the Home screen, tap  > .
All your contacts are listed in the **ALL CONTACTS** tab.
- 2 Tap the name of a contact to view their details.
- 3 Tap .

6.5 Email

Use this app to send or view emails.

On the Home screen, tap  > . Enter your email address and password to set up your email account(s).

- To set up your email account(s) manually, tap **Manual setup**; to set them up automatically, tap **Next**. Follow the on-screen instructions to complete the setup.
 - To add another account, tap  >  **Accounts** > **Add account**.
-  • To use web and data services, your device must be connected to the Wi-Fi or data networks. For more information on how to connect to networks, refer to *WLAN on page 49* or *More Settings on page 50*.
- Using the Internet browser or downloading from the Internet via your data network may incur extra charges depending on your data plan.



6.6 Snapdragon Camera





Use this app to take photos or record videos.

On the Home screen, tap  > . You can also directly open the camera app from the lock screen. Swipe the screen to right while tapping .











- The first time you open the Camera app, you are prompted to add location tag to the photos and display the information.
- If micro SD card is installed, the photos and videos will be saved on the internal storage.

6.6.1 Taking Photos

- 1 On the Home screen, tap  >  and make sure that camera mode is set to .
- 2 Aim the camera at the object. To zoom in or out, spread or pinch two fingers on the screen.
- 3 Tap  to take a photo. You can hear a ding sound.
Your device automatically focuses on the object if the ZSL option is off and saves the photo on your internal storage.
- 4 Swipe the screen from the right edge to view the photos taken. To go back to the viewfinder, swipe the screen from the left edge.

6.6.2 Taking Photos in Panoramic Mode







- 1 On the Home screen, tap  > .
- 2 Tap  and select  to switch to panoramic mode.
- 3 Tap  to take a panoramic photo. You can hear a ding sound.
- 4 Pan slowly to the left or right. If you are moving too quickly, a message **“Too fast”** appears on the screen. A progress bar  is displayed on the capturing screen.
- 5 Tap  to end taking a panoramic photo. You can hear a ding sound.
A progress bar  indicates the photo rendering status. To cancel rendering, tap .
- 6 To view the photos taken, swipe the screen from the right edge. To go back to the viewfinder, swipe the screen from the left edge.



- The setting for taking panoramic photos are not available.















6.6.3 Recording Videos

- 1 On the Home screen, tap  > .
- 2 Tap  and select  to switch to video mode.
- 3 Aim the camera at the object and adjust the image. To zoom in or out, spread or pinch two fingers on the screen.
- 4 Tap  to record a video. You can hear a ding sound.
- 5 Tap  to stop recording. You can hear a ding sound.
Your device automatically saves the video on your internal storage.
- 6 To view the recorded videos, swipe the screen from the right edge. To go back to the viewfinder, swipe the screen from the left edge.

6.6.4 Camera Settings

You can modify various camera options. This camera settings menu can only be accessed through this app.

- 1 On the Home screen, tap  > .
- 2 Tap the flash status icon on the bottom right of the screen, or tap and hold the viewfinder to change the camera settings.
 - Tap  to enable the HDR feature, which takes multiple photos at different exposures and combines them into one vibrant photo. When you disable the HDR feature, the icon at the bottom right changes into .
 - If you want to turn off the HDR feature, tap  and the flash will operate automatically instead.
 - Tap  to switch between the front and rear cameras.
 - Tap , , or  for more camera settings.
 - **Scene mode:** Tap to change the scene mode. You can select the mode among 19 modes.
 - **Store location:** Tap to select the checkbox to include location information for each photo using the device's GPS.
 - **Picture size:** Tap to select the size of photos in pixels.
 - **Histogram:** Tap to enable or disable the histogram. Histogram is a graph that shows the brightness distribution of a photo.
 - **Picture quality:** Tap to set the image quality. Higher quality images require more storage space.
 - **ZSL:** Tap to select the checkbox to turn on the ZSL option and to take a photo immediately after tapping . When this option is not selected, the camera will bring an image into focus before capturing it.
 - **Countdown timer:** Tap to set the timer to take photos automatically without tapping .
 - **Beep during countdown:** Tap to select the checkbox to set the beep sound while the timer counts down.
 - **Continuous shot:** Tap to select the checkbox to set continuous shooting mode to take multiple photos continuously by tapping and holding the .



- **AUTO HDR:** Tap to enable or disable the auto HDR.
- **HDR need 1x frame:** Tap to select the frame you used when you set the **AUTO HDR** in **Enable**. You can select **False** (single frame) or **True** (double frame).
- **Color effect:** Tap to set the color effect for an image. You can select the effect among 10 effects.
- **Face Detection:** Tap to select the checkbox to turn on or off the automatic face detection.
- **Touch AF/AEC:** Tap to select the checkbox to set the touch AF/AEC. This allows you to set focus and exposure values when the focus and exposure area appears by tapping the viewfinder.
- **Selectable Zone Auto Focus:** Tap to set a zone for auto focus.
- **Select Picture Format:** Tap to select the photo format you want to save as.
- **Saturation:** Tap to set the saturation level.
- **Contrast:** Tap to set the contrast level.
- **Sharpness:** Tap to set the sharpness level.
- **Select Auto Exposure Mode:** Tap to set how light values are calculated. **Frame Average** measures the entire frame. **Center Weighted** measures the light in the center of the scene. **Spot Metering** measures the light value at a specific location.
- **Anti Banding:** Tap to set the anti banding feature to decrease fluctuations in the brightness of images. Set to a higher frequency for more light oscillation.
- **Select ISO:** Tap to set the ISO number. Use a lower ISO number to make your camera less sensitive to light and use a higher ISO number to take a photo in dark conditions.
- **Wavelet Denoise Mode:** Tap to select the checkbox to remove the wavelet noise from images.
- **Exposure:** Tap to set the exposure value. Increasing the exposure value will double the amount of light captured by the camera and decreasing the exposure value will half the amount of light captured by the camera.
- **White balance:** Tap to select a suitable light source for your photo.
- **Flash mode:** Tap to enable or disable the flash or make flash operate automatically.
- **Focus mode:** Tap to select a focus mode appropriate for the photo.
- **Redeye Reduction:** Tap to reduce the red-eye effect in photos which often occurs when the flash is used in dark conditions.
- **Manual Exposure:** Tap to adjust the exposure value manually.
- **Manual White balance:** Tap to adjust the white balance value manually.
- **Manual Focus:** Tap to adjust the focus value manually.









In HDR mode, you cannot set the **Continuous Shot, Color effect, Touch AF/AEC, Saturation, Contrast, Sharpness, Select Auto Exposure, Exposure, White balance, Flash mode** and **Focus mode**.



6.6.5 Video Settings

You can modify various video options. This video settings menu can only be accessed through this app.

- 1 On the Home screen, tap  > .
- 2 Tap  and select  to switch to video mode.
- 3 Tap the flash status icon on the bottom right of the screen, or tap and hold the viewfinder to change the video settings.
 - Tap  to switch between the front and rear cameras.
 - Tap  and  for more video settings.
 - **IS:** Tap to select the checkbox to set digital image stabilization IS, which reduces blurring in a video by compensating for hand tremor and other movements.
 - **Time lapse:** Tap to turn the Time lapse feature on or off. Turn it on to set a time interval.
 - **Video quality:** Tap to set the video quality.
 - **Video Encoder:** Tap to set the video encoder. The SF550 supports MPEG4, H263, and H264 video playback.
 - **Audio Encoder:** Tap to set the audio encoder. The SF550 supports AMRNB and AAC audio formats.
 - **Video duration:** Tap to set the video duration.
 - **Store location:** Tap to select the checkbox to include location information for each video using the device's GPS.
 - **Color effect:** Tap and set the color effect used in video.
 - **Video HDR:** Tap to select the checkbox to turn on the HDR feature, which takes multiple videos at different exposures and combines them into one vibrant video.
 - **White balance:** Tap to select the most suitable light source for your video.
 - **Video High FrameRate:** Tap to select a high frame rate for your videos. Videos recorded with a higher frame rate capture movement more clearly.
 - **Flash mode:** Tap to select the checkbox to turn on or off the flash.

6.7 Calendar

Use this app to create, view, and manage events.

On the Home screen, tap  > . You can also add and tap a widget Settings on the Home screen.





To add events, you must set up an account. For information about how to set up an account, refer to [Accounts on page 55](#).

6 Applications







6.7.1 Creating Events

- 1 On the Home screen, tap  > .
- 2 Tap  > **Schedule**, **Day**, **3 Day**, **Week** or **Month**.
- 3 In **Day**, **3 Day** or **Week** view, tap a date or time to select it and tap it again to add events. If you try to add events in **Schedule** or **Month** view, tap a date and the screen will switch to **Day** view.
- 4 Tap the time and tap it again to add events.





You can also add events by tapping  at the bottom right of the screen in any view modes. Make sure you have to choose the date first.





6.7.2 Changing Calendar View

- 1 On the Home screen, tap  > .
- 2 Tap  and select one of the following options: **Schedule**, **Day**, **3 Day**, **Week** or **Month**.
- 3 Tap today's date  on the top right of the screen.

6.7.3 Viewing Events



- 1 On the Home screen, tap  > .
- 2 Tap  > **Schedule**, **Day**, **3 Day**, **Week** or **Month**.
- 3 In **Schedule**, **Day**, **3 Day** or **Week** view, tap an event to view its details. If you try to view an event's details in **Month** view, tap an event and the screen will switch to **Day** view.
- 4 Tap the event to view its details.

6.7.4 Editing and Deleting Events



- 1 On the Home screen, tap  > .
- 2 Tap  > **Schedule**, **Day**, **3 Day**, **Week** or **Month**.
- 3 In **Schedule**, **Day**, **3 Day** or **Week** view, tap an event to view its details. If you try to view an event's details in **Month** view, tap an event and the screen will switch to **Day** view.
- 4 Tap the event to view its details.
- 5 Tap  to edit the event and tap **SAVE**. If you want to delete the event, tap  > **DELETE**.





6.7.5 Refreshing the Calendar

- 1 On the Home screen, tap  > .
- 2 After adding, editing or deleting events, tap  > **Refresh**.

6.7.6 Searching for Events

- 1 On the Home screen, tap  > .
- 2 Tap  > **Search** and then enter the keywords.

6.7.7 Syncing Events

You can sync calendars with registering the Google accounts on your device. To register the accounts, tap  >  >  **Accounts** and restart the Calendar app. For more information on registering the Google account on your device, refer to *Accounts on page 55*.



6.8 Clock

Use this app to set an alarm, view the time in cities around the world, or use a timer or a stopwatch.

On the Home screen, tap  > .

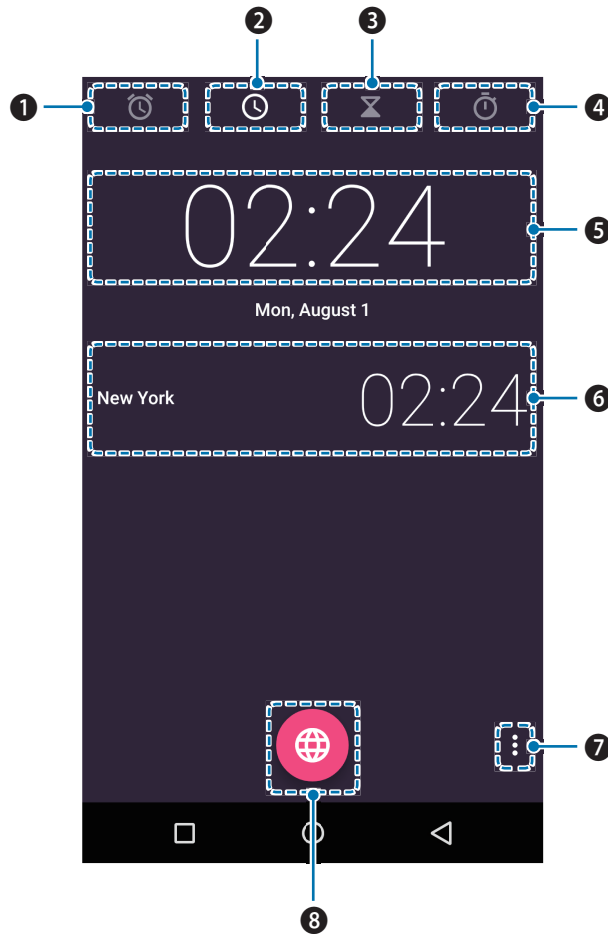





No.	Description
1	Alarm
2	Clock
3	Timer
4	Stopwatch
5	Current time and date of the location depending on your connected mobile network service
6	Current time and date of the added cities
7	More options
8	Add cities



6.8.1 Alarm and clock

You can set, and delete an with the Clock app.



To set an alarm

- 1 On the Home screen, tap  >  > .
- 2 Tap  and set the time for the alarm and tap **OK**.
- 3 Select the **Repeat** checkbox and select the days you want the alarm to sound on.
If you want to change the alarm ringtone, tap **Default ringtone**.
- 4 To make the device vibrate during the alarm, select the **Vibrate** checkbox.
- 5 Tap **Label** to name the alarm.





To delete an alarm

- 1 On the Home screen, tap  >  > .
- 2 Tap an alarm > .
- 3 Tap **UNDO** in the following pop-up box, if you do not want to delete the selected alarm.

To add cities

- 1 On the Home screen, tap  >  > .
- 2 Tap  to add cities, and select the checkboxes of the cities you want to add.
- 3 Tap  to save.





To switch to Night mode





- 1 On the Home screen, tap  >  > .
- 2 Tap  > **Night mode**.
Your device dims the screen lights and displays the current time. Tap the screen to go back to the Clock screen.

6 Applications











6.8.2 Timer

- 1 On the Home screen, tap  >  > .
- 2 Tap the keypad to specify the time period. It is entered in the following order: hour, minute, second. If you want to delete the number you entered, tap .
- 3 Tap  to start the timer.
The following icons are displayed on the timer screen.

Icon	Description
	Pause the timer.
	Restart the timer after pausing it.
Label	Make a name for the timer.
+1'	Add 1 minute to the current amount of time left.
	Discard the timer.
	Add a new timer. Swipe up and down to search for added timers.

6.8.3 Stopwatch



- 1 On the Home screen, tap  >  > .
- 2 Tap the clock in the middle in the screen or  to start the stopwatch.
The following icons are displayed on the stopwatch screen.

Icon	Description
	Pause the stopwatch.
	Restart the stopwatch.
	Record the lap times.
	Stop the stopwatch.
	Share the results. You can share the results via Bluetooth, email, etc.



6.8.4 Settings

You can modify various clock options. This clock settings menu can only be accessed through this app.

- 1 On the Home screen, tap  > .
- 2 Tap  > **Settings** on any tab of Clock app.

Clock

- **Style:** Tap and set the style of the Clock screen to analog or digital.
- **Automatic home clock:** Turn the Automatic home clock on to set a clock for your home city while traveling in a different time zone.
- **Home time zone:** Tap and set your local time zone.
- **Change Date & time:** Tap and change the date and time. It is connected to Date & time settings directly. For more information on changing the date and time, refer to *Date and Time on page 57*.

Alarms

- **Silence after:** Tap and set the duration of the alarm.
- **Snooze length:** Tap and set the snooze interval.
- **Alarm volume:** Tap and set the alarm volume.
- **Gradually increase volume:** Tap and set the volume of the alarm to increase gradually.
- **Volume buttons:** Tap and set the volume buttons on the side of you device to **Snooze**, **Dismiss**, or **Do nothing**.
- **Start week on:** Tap and set the starting day of the new week to **Saturday**, **Sunday** or **Monday**.

Timers

- **Timer ringtone:** Tap and set the ringtone for when the timer ends.
- **Gradually increase volume:** Tap and set the volume of the timer to increase gradually.





6.9 Downloads

Use this app to view your downloaded files.

On the Home screen, tap  > . You can view the file list by date or by size. Select a file to open with an appropriate app.

6.10 Calculator

Use this app for mathematical calculations.

On the Home screen, tap  > . Tap numbers and functions as you would do with a standard calculator.

6.11 Google Apps

Google provides entertainment, social network, and business apps. You may require a Google account to access some apps. For more information about accounts, refer to *Accounts on page 55*.

To view more app information, access each app's Help & feedback menu.

6.11.1 Chrome

Search for information and browse webpages.

6.11.2 Gmail

Send or receive emails via the Google Mail service.

6.11.3 Google

Search quickly for items on the Internet on your device.

6.11.4 Maps

Find your location on the map, search for locations, and view location information for various places.

6.11.5 Play Music

Discover, listen to, and share music on your device.

6.11.6 Play Movies & TV

Watch videos stored on your device and download various content to watch from the Play store.



6.11.7 Drive

Store your content on the cloud, access it from anywhere, and share it with others.

6.11.8 YouTube

Watch or create videos and share them with others.

6.11.9 Photos

Manage photos, albums, and videos that you have saved on the device.

6.11.10 Hangouts

Chat with your friends individually or in groups and use images, emoticons, and video calls while you are chatting.

6.11.11 Voice Search

Search quickly for items by saying a keyword or phrase.

6.11.12 Google Settings

Configure settings for some features provided by Google.

7 Settings



Use this app to configure your Android device.

On the Home screen, tap . You can also add and tap a widget Settings on the Home screen. Tap and enter your search term to search the Settings menu.

7.1 WLAN

On the Home screen, tap > **WLAN**.

Switch the Wi-Fi to **On** to connect to a Wi-Fi network.

- Tap and hold an available network to connect to it, remove it from the list, or modify its details.
- Tap > **Add network** to add a network manually.
- Tap > **Saved networks** to check the networks saved on your device.
- Tap > **Refresh** to refresh the list of available Wi-Fi networks.
- Tap > **Advanced** to customize Wi-Fi settings.

7.2 Bluetooth

On the Home screen, tap > **Bluetooth**.

Switch the Bluetooth to **On** to activate it and pair with other devices for information exchange.

- Tap the available device to pair with.
- Tap > **Refresh** to refresh the list of available Bluetooth devices.
- Tap > **Rename this device** to change the name of your device manually and to set the length of time for your device to appear on the search list.
- Tap > **Show received files** to show all files received via Bluetooth.

7.3 Data Usage

On the Home screen, tap > **Data usage**.

Turn **Cellular data** on to use the cellular data for mail app, GPS, etc.

- Turn **Set cellular data limit** on to make your device turn off cellular data once it reaches the set limit. The orange bar appears in graphs on the screen.
- Tap > **Restrict background data** to restrict the use of some apps and services unless your device is not connected to a Wi-Fi network.
- Tap > **Show Wi-Fi** to display the **WI-FI** tab in this settings menu. If you want to hide the **WI-FI** tab, tap **Hide Wi-Fi**.
- Tap > **Network restrictions** to restrict the use of apps in the background when connected to a Wi-Fi network. The app may warn you before using these networks for large downloads.
- Tap > **Cellular networks** to configure **SUBS Settings**.



7.4 More Settings

Use this menu to change more wireless and networks settings for interaction with other devices.

On the Home screen, tap  >  **More**.

- **Airplane mode:** Tap to start Airplane mode. All wireless and mobile services are disabled when Airplane mode is activated.
- **Wifi mode:** Tap to switch Wi-Fi mode on.
- **Default SMS app:** Tap to specify a default SMS app among various SMS apps in your device.
- **Tethering & portable hotspot**
 - **USB tethering:** Use USB tethering to share the data connection with a computer via USB.
 - **Portable WLAN hotspot:** Use the portable WLAN hotspot to share the data connection through the WLAN network.
 - ✔ **The Portable WLAN hotspot feature requires more battery power and increases your data usage. It may incur extra charges depending on your data plan.**
 - **Set up WLAN hotspot:** Configure WLAN hotspot name and security type.
 - **Bluetooth tethering:** Use Bluetooth tethering to share the data connection via Bluetooth.
- **VPN:** Tap  to set up and edit virtual private network (VPN) profiles and connect to the VPNs.
 - ✔ **You need to set a screen lock pattern, PIN, or password before using the VPNs. For information on how to set up a lock screen, refer to *Security on page 54*.**
- **Cellular networks:** Configure **SUBS Settings**.
- **Mobile plan:** Tap to change mobile network settings.
- **Emergency broadcasts:** Set to receive alerts for emergency situations.

7.5 Buttons



Use this menu to set button functions.

On the Home screen, tap  >  **Buttons**.

Power Button

- **End Call:** Tap to end the call by pressing Power button.

Home button

- **Long press action:** Select an action to use when tapping and holding Home button .
- **Double tap action:** Select an action to use when tapping Home button  twice.



Menu button

- **Short press action:** Select an action to use when tapping Menu button .
- **Long press action:** Select an action to use when tapping and holding Menu button .
- **Answer Call:** Tap to answer an incoming call by tapping Home button .

Volume buttons

- **Wake up device:** Tap to wake your device by pressing any volume button.

7.6 Display



Use these Display settings to change the screen brightness and wallpaper, enable screen rotation, set the sleep time, change the font size, and configure other features of the display.

On the Home screen, tap  >  **Display**.

- **Brightness level:** Tap and move the slider to adjust the screen brightness.
- **Adaptive brightness:** Enable this option to set your device to automatically optimize the brightness level for available light.
- **Wallpaper:** Select an image for the Home screen background.
 - **Gallery:** Images saved on your Gallery
 - **Live Wallpapers:** Animated wallpaper image installed on your device
 - **Photos:** Photos taken by your device's camera or downloaded from the Internet
 - **Wallpapers:** Images saved on your device
- **Sleep:** Tap and select the length of time the device waits before turning off the screen and locking itself.
- **Daydream:** Tap and switch this option to **On** for the device to show the clock, colors, photo frame, photo table, or photos while the device is locked, charging, or locked and charging.
 - Tap to select a desired action.
 - Tap **Start now** or **When to daydream** to set when to use this feature.
- **Font size:** Tap to change the font size.
- **When device is rotated:** Tap and select one from two options: **Rotate the contents of the screen**, **Stay in current orientation**.
- **Cast screen:** Tap to mirror your device's screen to a TV or similar device when the Miracast dongle or Chromecast dongle is detected.
- **Blur Effect:** Tap to apply the blur effect on some screens.



7.7 Sound and Notification

Use this Sound settings to configure sound settings such as the call ringtone or system notification volume. On the Home screen, tap  >  **Sound & notification**.

Sound

- **Media volume:** Tap and move the slider to adjust the volume of media.
- **Alarm volume:** Tap and move the slider to adjust the volume of the alarms.
- **Ring volume:** Tap and move the slider to adjust the volume of ringtones.
- **Also vibrate for calls:** Turn on this option to set your device to vibrate for incoming calls.
- **Interruptions:** Tap to set your device to disable notifications while using selected apps.
 - **When calls and notifications arrive:** Tap to select the interruption options during a call.
 - **Events and reminders:** Turn on this option to put priority on this menu when other notifications arrive.
 - **Calls:** Turn on this option to put priority on this menu when other notifications arrive.
 - **Messages:** Turn on this option to put priority on this menu when other notifications arrive.
 - **Call/message from:** Tap and select the sender group you want to put priority when other notifications arrive during a call or message.
 - **Downtime:** Set your device to only sound or vibrate for select notifications during a set time. Tap **Days**, **Start time**, **End time** and **Interruptions allowed** to configure the downtime.

 **Alarms are always priority interruptions.**

- **Phone ringtone:** Tap to select a ringtone to alert you of incoming calls. Tap on a ringtone to hear it. If you decide to set it as a ringtone, tap **OK**. If not, select another ringtone or tap **CANCEL**.
- **Default notification ringtone:** Tap to select a notification sound to alert you of system notifications. Tap on a sound to hear it. If you decide to set it as a notification sound, tap **OK**. If not, select another sound or tap **CANCEL**.
- **Other sounds:** Tap to set other sound options except the ringtone and notification sounds.
 - **Dial pad tones:** Turn on this option to set your device to emit a sound when you tap the keypad.
 - **Screen locking sounds:** Turn on this option to set your device to emit a sound when you unlock or lock the screen.
 - **Touch sounds:** Turn on this option to set your device to emit a sound when you tap the screen.
 - **Vibrate on touch:** Turn on this option to set your device to vibrate when you tap soft keys or during certain screen interactions.

Notification

- **When device is locked:** Tap and select the notifications to display when the device is locked.
- **App notifications:** Tap and select the app that you want to block or put priority for its notification.
- **Notification access:** Tap to enable or disable notifications while using an app that supports the alarm access.



7.8 Storage

You can check the internal or SD card storage space. Tap **Erase SD card** to delete all data saved on the SD card.

On the Home screen, tap  >  **Storage**.

7.9 Battery

Use these Battery settings to monitor battery usage.

On the Home screen, tap  >  **Battery**.

You can check:

- Battery charging status
- How long your device has been running on battery power
- Tap  > **Battery saver** to improve the battery life.

7.10 Apps

You can check the status of all apps in your device using the **DOWNLOADED**, **ON SD CARD**, **RUNNING**, and **ALL** tabs.

On the Home screen, tap  >  **Apps**.

- **Sort by size:** Tap to sort the apps by size, starting with the biggest one.
- **Sort by name:** Tap to sort the apps into alphabetical order.
- **Reset app preferences:** Tap to reset app's preferences to the default settings.
- **Preferred install location:** Tap to set the preferred installation location for new apps.
- **Show cached processes:** Tap to show the cached processes of apps.
- **Show running services:** Tap to only show the running services and apps.

7.11 Users

Use this User settings to manage users of your device.

On the Home screen, tap  >  **Users**.

- Tap **Add user** to add other users.
- Tap  and select the checkbox for **Add users when device is locked** to add other users when the device is locked.



7.12 System profiles

Use this System profiles settings to set up and manage system profiles as you desired.

On the Home screen, tap  >  **System profiles**.

7.13 Location

Switch this option to **On** to detect your device's location.

On the Home screen, tap  >  **Location**.

- **Mode:** Tap and select the method for determining your location such as GPS, Wi-Fi and cellular networks, or Qualcomm® IZat™ hardware.

7.14 Security

Use this Security settings to set a lock screen and change settings to secure your device.

On the Home screen, tap  >  **Security**.

Screen security

- **Screen lock**
 - **None:** The screen is unlocked at all times. When you press the Power button, the Home screen appears.
 - **Swipe:** Drag the lock icon to unlock the screen.
 - **Pattern:** Draw a pattern to unlock the screen.
 - **PIN:** Enter a PIN to unlock the screen.
 - **Password:** Enter a password to unlock the screen.
- **Owner info**
 - **Show owner info on lock screen:** Tap and select the checkbox to display the owner information on the lock screen. Then enter text to display. If you do not select the checkbox, the input field will be deactivated.
- **Lockscreen shortcuts:** Tap and select an app to launch when locking the screen.
- **Smart Lock**
 - **Trusted devices:** Add a trusted device to keep your device unlocked when connecting via Bluetooth or NFC.
 - **Trusted places:** Add a trusted place to set your device to unlock when it is in select locations.
 - **Trusted face:** Add a trusted face to unlock your device when it recognizes the user's face.
 - **Trusted voice:** Add a trusted voice to unlock your device when it recognizes the user's voice.
 - **On-body detection:** Set your device to unlock when you hold or carry it in your hands. Your device will lock when it detects that it has been laid down.



Encryption

- **Encrypt phone:** Tap to encrypt your accounts, settings, downloaded apps and their data, and other files. Set a numeric PIN or password for encryption. You must enter the password each time you turn on the device.

 You can only decrypt the device by performing a factory reset. Encrypting your device may take more than an hour. Charge your battery before encrypting, and keep your phone plugged in until encryption is complete. If not, you may lose some or all of your data.

App security

- **SMS message limit:** Tap and select the message limit for 15 minutes.
- **Blacklist:** Tap and configure a blacklist to block incoming calls and messages.

Passwords

- **Make passwords visible:** By default, the device hides passwords for security when you enter them. Turn on this option to make the passwords visible as they are entered.

Device administration

- **Device administrators:** Tap to manage device administrators.
- **Unknown sources:** Turn on this option to allow your device to install or download apps from unknown sources.

Credential storage

- **Trusted credentials:** Tap to enable or disable the trusted system CA certificates.
- **Install from storage:** Tap to install certificates from the SD card.
- **Clear credentials:** Tap to delete all certificates.

Advanced

- **Trust agents:** Tap to enable or disable trust agents.
- **Screen pinning:** Tap to disable or enable screen pinning.
- **Apps with usage access:** Tap to manage which apps are allowed access to app usage data.

7.15 Accounts

Use this settings to manage accounts of your device.

On the Home screen, tap  >  **Accounts**.

- Tap **Add account** to add other accounts.
- Tap  and select the checkbox for **Auto-sync data** to sync the data automatically.



7.16 Language and Input

Use this Settings menu to change language and input method.

On the Home screen, tap > **Language & input**.

- **Language:** Tap and select the default language for all menus and apps.
- **Spell checker:** Turn on this option to enable the spell checker and configure its settings and language.
- **Personal dictionary:** Tap to view and add words to your personal dictionary.

Keyboard & input methods

- **Current Keyboard:** Tap to view the current keyboard you are using. Tap **CHOOSE KEYBOARDS** to select a different keyboard to use.
- **Google Keyboard:** Tap to configure the Google keyboard settings.
- **Google voice typing:** Tap to configure the Google voice typing settings.

Speech

- **Voice input:** Tap to select either the basic or enhanced voice input service.
- **Text-to-speech output**
 - **Preferred engine:** Tap to select a speech synthesis engine. To change its settings, tap .
 - **Speech rate:** Tap to select the speed at which the text is spoken.
 - **Listen to an example:** Tap to listen to a short part of the spoken text.

Mouse/trackpad

- **Pointer speed:** Tap and move the slider to adjust the pointer speed for the mouse or trackpad that is connected to your device.

7.17 Backup and Reset

Use this Settings menu to perform factory reset.

On the Home screen, tap > **Backup & reset**.

Backup & restore

- **Back up my data:** Turn on this option to back up app data, Wi-Fi passwords and other data to Google servers.
- **Backup account:** Tap to select the account where you want to back up the data.
- **Automatic restore:** Turn on this option to reinstall the apps, and restore backed up settings and data.

Personal data

- **Factory data reset:** Tap **RESET PHONE** to delete all data from the device's internal storage. The device turns off and then reboots automatically.



7.18 Date and Time

Use this setting to manage the date and time settings.

On the Home screen, tap  >  **Date & time**.

- **Automatic date & time:** Turn on this option to set the date and time automatically in accordance with the network-provided time.
- **Automatic time zone:** Turn on this option to set the time zone automatically in accordance with the network-provided time zone.
- **Set date:** Tap to set the date manually by tapping the date on the on-screen calendar. You can navigate through the calendar by swiping up and down.
- **Set time:** Tap to set the time manually by tapping the time on the on-screen clock.
- **Select time zone:** Tap and select the time zone manually.
- **Use 24-hour format:** Turn on this option to use 24-hour format. If turned off, the device uses the 12-hour format with AM/PM notation.

7.19 Accessibility

Use this setting to customize your device to improve its accessibility.

On the Home screen, tap  >  **Accessibility**.

- **TalkBack:** Tap and switch this option to **On** to set your device to provide spoken feedback to help blind and visually impaired users.
- **Switch Access:** Tap and switch this option to **On** to control your device using configurable key combinations.
- **Captions:** Tap and switch this option to **On** to make captions appear on the bottom of the screen. You can set the language, text size, and caption style.
- **Magnification gestures:** Tap and switch this option to **On** to zoom in and out by triple-tapping the screen. You can also temporarily magnify screen content by triple-tapping and holding it.
- **Large text:** Tap and turn on this option to enlarge the text size.
- **High contrast text:** Tap and turn on this option to fix the text color as black or white to make it easier to read.
- **Power button ends call:** Tap and turn on this option to end the call by pressing the Power button.
- **Auto-rotate screen:** Tap and turn on this option to make the screen rotate automatically when you move the device between landscape and portrait orientation.
- **Speak passwords:** Tap and turn on this option to set the device to read passwords aloud as you enter them.
- **Accessibility shortcut:** Tap and switch this option to **On** to enable accessibility features quickly from the accessibility shortcut.
- **Text-to-speech output**
 - **Preferred engine:** Tap to select a speech synthesis engine. To change its settings, tap .
 - **Speech rate:** Tap to select the speed at which the text is spoken.
 - **Listen to an example:** Tap to listen to a short demonstration of the spoken text.

7 Settings



- **Touch & hold delay:** Tap and select the length of time required before your device detects that the user is touching and holding the screen.
- **Touch Type:** Tap and select your preferred method to interact with your device, such as with gloves or pens.
- **Color inversion:** Tap and turn on this option to invert the colors on the screen.
- **Color correction:** Tap and switch this option to compensate for color blindness. You can also select the correction mode for each type of color blindness.

7.20 Printing

Use this setting to print documents from your device directly with app that support the Wi-Fi or Cloud printing feature. You can specify the default printer.

On the Home screen, tap  >  **Printing**.

7.21 About Phone

Use this Settings menu to view the following information about your device: **Status**, **Legal information**, **Model number**, **Processor info**, **Android version**, **Kernel version**, and **Build number**.

On the Home screen, tap  >  **About phone**.



Physical Characteristics

Dimensions (W x H x D)	78.6 x 154.8 x 6.9 mm
Weight	138.6 g
Display	5.5 inch FHD(1920 x 1080) DisplayCapacitive Touch ScreenCorning Gorilla Glass III
Battery	2600 mAh, Li-ion
Expansion slot	Customer-accessible microSD slot for removable memory cards with a capacity of up to 64 GB
SIM slot	1 SIM
Audio	Mono speaker, Headset jack, Microphone
Camera	Main (Rear): 13 megapixel auto-focus camera with LED flash Sub (Front): 5 megapixel front camera for video conference
Interface	Micro USB
GPS	GPS with A-GPS, Glonass
Sensor	Ambient Light, Accelerometer, e-compass, Proximity

Performance Characteristics

Processor	Quad Core 1.2 GHz
OS	Android 5.1
System memory	2 GB RAM
Built-in storage	16 GB

User Environment Characteristics

Operating temperature	-20°C to 55°C (-4°F to 131°F)
Storage temperature	-30°C to 70°C (-22°F to 158°F)
Humidity	65% non-condensing: Operation 95% non-condensing: Storage



Communication Options

WWAN Radio	GSM/GPRS/EDGEWCDMA/HSDPA/HSUPA/HSPA+LTE
WLAN Radio	802.11 a/b/g/n (2.4 G and 5 G)
WPAN Radio	Bluetooth V4.1 BLE, Class 1

Accessories

Accessories	Protective Case, Neck Strap
-------------	-----------------------------



Please ask your sales representative for the specifications not listed above or for the future upgradeable specifications.



The battery does not charge properly.

- Ensure that your device and the charging cable are connected.
- If the battery does not charge completely, it may be dead or defective. Replace the battery with a new one.
(The warranty period for battery replacement is six months.)

The battery life got shorter.

When you use network data or peripheral device such as wireless LAN or Bluetooth that require more power, your device may use more battery than usual. If it happens for an extended period of time, your battery may be dead. Then replace it with a new battery.

I dropped the device in the water.

Turn off the device and take out the battery. Place the device and battery in a dry place. Let them dry completely for a considerable period of time, and then turn the device back on. If it does not turn back on, contact our service center.

My device gets too hot to touch.

It is normal for the device to warm up while it is receiving a poor signal, performing an intense workload, or charging. It should cool down if you stop using the device for a certain amount of time. If the problem continues, contact the manufacturer. It may result in a burst battery or fire.

How do I get the repair service?

You can contact your local sales representative or you can send the device via a delivery service to Bluebird's Korean headquarters. When sending the package, make sure you pay for the shipping fee in advance. When the repair is finished, Bluebird will cover the shipping cost.



FCC compliance information

This device complies with Part 15 of the FCC's Rules. Operation is subject to the following two Conditions:

- This device may not cause harmful interference, and
- This device must accept any interference received, including interference that may cause undesirable operation.

This device complies with part 15 of the FCC Rules. Operation is subject to the condition that this device does not cause harmful interference.

The antenna must be installed such that 20 cm is maintained between the antenna and users, and the transmitter module may not be co-located with any other transmitter or antenna.

End users cannot modify this transmitter device. Any Unauthorized modification could void the user's authority to operate this device.

Part 15.105 (B)

This equipment has been tested and found to comply with the limits for a Class B digital device, pursuant to part 15 of the FCC Rules. These limits are designed to provide reasonable protection against harmful interference in a residential installation. This equipment generates, uses and can radiate radio frequency energy and, if not installed and used in accordance with the instructions, may cause harmful interference to radio communications. However, there is no guarantee that interference will not occur in a particular installation. If this equipment does cause harmful interference to radio or television reception, which can be determined by turning the equipment off and on, the user is encouraged to try to correct the interference by one or more of the following measures:

- Reorient or relocate the receiving antenna.
- Increase the separation between the equipment and receiver.
- Connect the equipment into an outlet on a circuit different from that to which the receiver is connected.
- Consult the dealer or an experienced radio/TV technician for help.

Modifications not expressly approved by the manufacturer could void the user's authority to operate the equipment under FCC rules.

FCC 15.407 (g) states

Manufacturers of U-NII devices are responsible for ensuring frequency stability such that an emission is maintained within the band of operation under all conditions of normal operation as specified in the users manual.

Since this is an Indoor Only device (required for this band) you do not need to worry about the extreme frequency Stability over wide temperatures, but you can show that the frequency Generation portion of this device (from the schematic) has its own stated stability that would never allow the device to generate emissions or part of the spectrum outside of the authorized band (can be determined by looking at the Occupied BW plots to see how much margin to the band edge is available).

If the devices in the future use the other higher frequency UNII bands, and the devices can be used outdoors, you may need to provide details of stability over a much wider temperature range (depending on the use conditions stated in the manual).

Most compliance for this requirement is stated from the specification of the frequency generation portion of the device and not necessarily through additional testing.



IEC 60417-6044



Do not listen to sound at high volume for long periods. It may cause hearing damage. Also, only use compatible receiver, headphones, or earpieces with your device.

CE



Hereby, Bluebird Inc. declares that this SF550 is in compliance with the essential requirements and other relevant provisions of directive 1999/5/EC.

To comply with CE RF exposure requirements, the handset must be kept 0.59 inches (1.5cm) from the body without any reference to a particular side or edge.

Any beltclips, holsters, and similar accessories containing metallic components may not be used.

Body-worn accessories that cannot maintain 0.59 inches (1.5cm) separation distance between the user's body and the handset, and have not been tested for typical body-worn operations may not comply with CE RF exposure limits and should be avoided.

European Union (EU) Waste of Electrical and Electronic Equipment (WEEE) directive



According to the European Union's WEEE directive, this symbol means that products sold into EU countries must dispose electrical device and/ or its battery separately from household waste. Disposing of the device separately will help conserve resources and energy and contribute to human health and environment protection.

Customers or end-users in EU countries should contact their local equipment supplier representative or service centre for information about the waste collection system in their country.



ISED Compliance information

This device complies with Industry Canada's licence-exempt RSSs. Operation is subject to the following two conditions:

- (1) This device may not cause interference; and
- (2) This device must accept any interference, including interference that may cause undesired operation of the device.

Le présent appareil est conforme aux CNR d'Industrie Canada applicables aux appareils radio exempts de licence. L'exploitation est autorisée aux deux conditions suivantes :

- (1) l'appareil ne doit pas produire de brouillage;*
- (2) l'utilisateur de l'appareil doit accepter tout brouillage radioélectrique subi, même si le brouillage est susceptible d'en compromettre le fonctionnement.*

Body-worn Operation

This device was tested for typical body-worn operations with the back of the phone kept 1 cm (0.39 inches) between the user's body and the back of the phone. To comply with IC RF exposure requirements, a minimum separation distance of 1 cm (0.39 inches) must be maintained between the user's body and the back of the phone.

Any belt-clips, holsters, and similar accessories containing metallic components may not be used.

Body-worn accessories that cannot maintain 1 cm (0.39 inches) separation distance between the user's body and the back of the phone, and have not been tested for typical body worn operations may not comply with IC RF exposure limits and should be avoided.

Utilisation comme appareil portatif

Ce téléphone a été testé en vue d'une utilisation type comme appareil portatif, avec une distance de 1 cm (0,39 po) entre l'arrière de l'appareil et le corps de l'utilisateur. Pour satisfaire aux exigences de la IC en matière d'exposition aux radiofréquences, l'utilisateur doit maintenir une distance d'au moins 1 cm (0,39 po) entre son corps et l'arrière du téléphone. Tout les pinces de ceinture, les étuis et autres accessoires semblables d'autres marques et contenant des composantes métalliques ne peuvent pas être utilisés. Les accessoires portatifs qui empêchent le maintien d'une distance de 1 cm (0,39 po) entre le corps de l'utilisateur et l'arrière du téléphone et qui n'ont pas été testés en vue d'une utilisation type comme accessoires portatifs peuvent ne pas satisfaire aux limites d'exposition aux radiofréquences stipulées par la IC et, par conséquent, ne doivent pas être utilisés.



Warranty certificate

Thank you for purchasing a product from Bluebird Inc.

- In case of accessories such as batteries, only those that match the sales list managed by the Customer Service Center will be eligible for customer service.
- A repair or an exchange of batteries that does not match the sales list of the Customer Service Center due to the carelessness of the customer will be fully charged.

Name of Product	
Name of Model	SF550
Date of Purchase	
Manufacture Number	
Place of Purchase	
Term of Guarantee	1 year from purchase

Warranty information

- Bluebird Inc. (hereinafter referred to as Bluebird) provides the warranty service for its products in compliance with the Bluebird's warranty program.
- Upon receiving a notification on a defect of its product within the range of warranty during the warranty period, Bluebird will repair or replace the defective product according to its warranty policy.
- If the defective product within the range of warranty is not repairable or replaceable, Bluebird shall refund the purchasing price within a designated period from the date of receiving a notice of defect.
- Bluebird assumes no responsibility for repairing, replacement or refund until it receives the defective product from the customer. The replacement shall be equivalent to a new product in the aspect of performance.
- Bluebird products may contain the recycled products, components or materials equivalent to new products in the aspect of performance.
- This warranty is applied to software products only when the programming commands are not executed. Bluebird does not guarantee interruption-free or error-free performance.



Customer support



Before asking for after-sales service, please back up the data on the device. We do not back up data from the products sent to the Customer Service Center. Therefore, we assume no responsibility for loss/deletion of data.

Customer Service Center

#1103, Gplus Kolon Digital Tower 11F,
Digital-ro 26-gil 123, Guro-gu, Seoul, Republic of Korea(08390)

- Fax: +82-2-6499-2242
- Email: rma@bluebirdcorp.com
- Hours: 9:30 a.m. - 6:30 p.m. (GMT Time: +9 Hours)



The center is closed on Saturdays, Sundays, and Korean national holidays

Registering for After-Sales Service

- We receive the products for our after-sales service through mail, delivery services and hand delivery only in principle.
- If you bought the product from a party other than Bluebird or an authorized Bluebird reseller, you need to register the product before using our after-sales service.
- Please enclose an evidence of purchase or the product receipt for our after-sales service.
- Please enclose your name, telephone number, address and details of the problem for a prompt service.
- You can ask for our after-sales service by contacting your authorized Bluebird dealer or the Customer Service Center in the head office.
- Do not intentionally damage the label on the product.
- A damaged label may result in a disadvantage to the customer.
- When you return the product to Bluebird for service, please put the product in a protective box.
- The warranty will not cover any damage which occurs during delivery. We advise you to use the box and protective cover supplied with the product.
- Make sure to deliver the product in a safe way. Bluebird assumes no responsibility for the loss of the product during delivery.



Charged services

- In the following cases, it will be charged when requesting for after-sales service.
 - Service request due to inappropriate use of the device by the customer
 - Loss of PIN number
 - Use of programs that might affect the program (over-clock, forceful changes in the input of the system, personal developments)
- Faults caused by the customer.
 - Defect due to inappropriate or careless use of the product (dropping, submersion under water, shock, damage, unreasonable operations, etc.)
 - Defect due to a repair or unauthorized technician
 - Defect caused intentionally or by the carelessness of the customer
 - Defect due to the use of fraudulent parts or components
- Other cases
 - Defect due to nature (damage caused by fire, wind, flooding, etc.)
 - Accessories are out of warranty (accessories like battery/charger/cable/adapter, etc. have a warranty of 6 months)
- Regulations for repairs after charged services
If the same fault occurs in the part that has been repaired within a 1 month (30 days), the part will be repaired free of charge.



No refunds will be offered in the following situations:

- The product seal has been removed (if applicable).
- The product has been damaged due to careless use by the customer or due to a natural disaster (floods, rain, fire, etc.).
- Loss of product or other components (manual, connecting cables, etc).
- DOA (Dead on Arrival) policy
If your product is DOA (Dead on Arrival), or has malfunction within 30 days of purchase (DOA period), the product will either be exchanged or provided with after-sales service.



BLUEBIRD CUSTOMER SERVICE

Operating Hours

Monday to Friday 9:30 A.M. - 6:30 P.M.
(GMT Time: +9 Hours)
The center is closed on Saturdays,
Sundays, and Korean national holidays.

Customer Service Center

#1103, Gplus Kolon Digital Tower 11F,
Digital-ro 26-gil 123, Guro-gu, Seoul,
Republic of Korea(08390)

Bluebird constantly strives to bring utmost satisfaction to all our customers.